

# Instruction Manual

Side by Side  
Refrigerator Freezer

IIF269177IDD  
IIF269177BSDD

**iiglo**<sup>®</sup>

# Table of Contents

- Safety information ..... 3
  - Children and vulnerable people safety ..... 3
  - General safety ..... 3
  - Daily use ..... 4
  - Care and cleaning ..... 5
  - Installation ..... 5
  - Service ..... 5
  - Energy saving ..... 5
  - Environment Protection ..... 6
  - Packaging materials ..... 6
  - Disposal of the appliance ..... 6
- Overview ..... 7
- Installation ..... 7
  - Remove the doors ..... 7
  - Space Requirement ..... 8
  - Levelling the refrigerator ..... 8
  - Positioning ..... 9
  - Location ..... 9
  - Electrical connection ..... 9
- Daily Use ..... 9
  - Using the Control Panel ..... 9
  - Buttons ..... 9
  - Display ..... 10
  - Door open alarm ..... 10
  - Child safety lock (LOCK MODE) ..... 10
  - First use ..... 11
  - Freezing fresh food ..... 11
  - Thawing ..... 11
  - Ice cube maker ..... 11
  - Movable shelves ..... 11
  - Positioning the door balconies ..... 12
- Helpful tips ..... 12
  - Tips for freezing ..... 12
  - Tips for storage of frozen food ..... 12
  - Tips for fresh food refrigeration ..... 12
  - Tips for refrigeration ..... 12
- Cleaning ..... 13
- Troubleshooting ..... 14

# Safety information

In the interest of your safety and to ensure correct use, before installing and first using the appliance, read this user manual carefully, including its hints and warnings. To avoid unnecessary mistakes and accidents, it is important to ensure that anyone using the appliance are thoroughly familiar with its operation and safety features. Save these instructions and make sure that they remain with the appliance if it is moved or sold, so that everyone using it through its life will be properly informed on appliance use and safety.

For the safety of life and property, always observe the precautions in these user instructions, as the manufacturer is not responsible for damages caused by negligence.

## Children and vulnerable people safety

- This appliance can be used by children aged from 8 years and above and persons with reduced physical, sensory or mental capabilities or lack of experience and knowledge if they have been given supervision or instruction concerning use of the appliance in a safe way and understand the hazards involved.
- Children aged from 3 to 8 years are allowed to load and unload this appliance.
- Children should be supervised to ensure that they do not play with the appliance.
- Cleaning and user maintenance shall not be performed by children unless they are aged from 8 years and above and supervised.
- Keep all packaging well away from children. There is risk of suffocation.
- If you are discarding the appliance, pull the plug out of the socket, cut the mains cable (as close to the appliance as you can) and remove the door to prevent children playing from suffering electric shock or to locking themselves inside.
- If this appliance with magnetic door seals is to replace an older appliance with a spring lock (latch) on the door or lid, be sure to disable the spring lock before you discard the old appliance. This will prevent it from becoming a death trap for a child.

## General safety

⚠ WARNING! Keep ventilation openings, in the appliance enclosure or in the built-in structure, clear of obstruction.

⚠ WARNING! Do not use mechanical devices or other means to accelerate the defrosting process, other than those recommended by the manufacturer.

⚠ WARNING! Do not damage the refrigerant circuit.

⚠ WARNING! Do not use other electrical appliances (such as ice cream makers) inside of refrigerating appliances, unless they are approved for this purpose by the manufacture.

⚠ WARNING! Do not touch the light bulb if it has been on for a long period of time because it could be very hot.<sup>1</sup>

- Do not store explosive substances such as aerosol cans with a flammable propellant in this appliance.
- The refrigerant isobutane (R-600a) is contained within the refrigerant circuit of the appliance, a natural gas with a high level of environmental compatibility, which is nevertheless flammable.
- During transportation and installation of the appliance, be certain that none of the components of the refrigerant circuit are damaged.
  - avoid open flames and sources of ignition
  - thoroughly ventilate the room in which the appliance is situated
- It is dangerous to alter the specifications or modify this product in any way. Any damage to the mains cable may cause a short circuit, fire and/or electric shock.
- This appliance is intended to be used in households and similar applications such as

- staff kitchen areas in shops, offices and other working environments;
- farmhouses and by clients in hotels, motels and other residential type environments;
- bed and breakfast type environments;
- catering and similar non-retail applications

⚠ WARNING! Any electrical components (plug, mains cable, compressor etc.) must be replaced by a certified service agent or qualified service personnel.

⚠ WARNING! The light bulb supplied with this appliance is a “special use light bulb” usable only with the appliance supplied. This “special use light” is not usable for domestic lighting.<sup>1)</sup>

- Mains cable cord must not be lengthened.
- Make sure that the mains plug is not squashed or damaged by the back of the appliance. A squashed or damaged plug may overheat and cause a fire.
- Make sure that you can access the mains plug of the appliance.
- Do not pull the mains cable.
- If the mains plug socket is loose, do not insert the mains plug. There is a risk of electric shock or fire.
- Do not operate the appliance without the light.
- This appliance is heavy. Care should be taken when moving it.
- Do not remove or touch items from the freezer compartment if your hands are damp/wet, as this could cause skin abrasions or frost/freezer burns.
- Avoid prolonged exposure of the appliance to direct sunlight.

1) If there is a light in the compartment.

## Daily use

- Do not put hot items on the plastic parts in the appliance.
- Do not place food products directly against the rear wall.
- Frozen food must not be re-frozen once it has been thawed out.<sup>1)</sup>
- Store pre-packed frozen food in accordance with the frozen food manufacture, s instructions.<sup>1)</sup>
- Always observe the manufacture’s storage recommendations. Refer to relevant instructions.
- Do not place carbonated or fizzy drinks in the freezer compartment as it creates pressure on the container, which may cause it to explode, resulting in damage to the appliance.<sup>1)</sup>
- Ice lollies can cause frost burns if consumed straight from the appliance.<sup>1)</sup>

To avoid contamination of food, please respect the following instructions

- Opening the door for long periods can cause a significant increase of the temperature in the compartments of the appliance.
- Clean regularly surfaces that can come in contact with food and accessible drainage systems.
- Clean water tanks if they have not been used for 48h; flush the water system connected to a water supply if water has not been drawn for 5 days.
- Store raw meat and fish in suitable containers in the refrigerator, so that it is not in contact with or drips onto other food.
- Two-star frozen-food compartments (if present in the appliance) are suitable for storing pre-frozen food, storing or making ice-cream and ice cubes.

- One-, two- and three-star compartments (if present in the appliance) are not suitable for freezing fresh food.
- If the appliance is left empty for long periods, switch off, defrost, clean, dry and leave the door open to prevent mould developing within the appliance.

## Care and cleaning

- Before maintenance, switch off the appliance and disconnect the mains plug from the mains socket.
- Do not clean the appliance with metal objects.
- Do not use sharp objects to remove frost from the appliance. Use a plastic scraper.<sup>1</sup>
- Regularly examine the drain in the refrigerator for defrosted water. If necessary, clean the drain. If the drain is blocked, water will collect in the bottom of the appliance.<sup>2</sup>

1) If there is a freezer compartment.

2) If there is a fresh-food storage compartment.

## Installation

Important! For electrical connection carefully follow the instructions given in specific paragraphs.

- Unpack the appliance and check for damage. Do not connect the appliance if it is damaged. Report possible damage immediately to the vendor and retain the packaging.
- It is advisable to wait at least four hours before connecting the appliance to allow the oil to flow back into the compressor.
- Ensure adequate air circulation around the appliance to avoid overheating. To achieve sufficient ventilation, follow the installation instructions.
- Wherever possible, position the product against a wall to avoid contact with hot parts (compressor, condenser) to prevent possible burns.
- The appliance must not be located close to radiators or cookers.
- Make sure that the mains plug is accessible after installation of the appliance.

## Service

- Any electrical work required to do the servicing of the appliance should be carried out by a qualified electrician or competent person.
- This product must be serviced by an authorized Service Center, and only genuine spare parts must be used.

## Energy saving

- Do not put hot food in the appliance;
- Do not pack food close together, as this prevents air circulating;
- Make sure food does not touch the back of the compartment(s);
- If electricity goes off, do not open the door(s);
- Do not open the door(s) frequently;
- Do not keep the door(s) open for too long;
- Do not set the thermostat to exceedingly cold temperatures;
- Some accessories, such as drawers, can be removed for larger storage volume and lower energy consumption.

## Environment Protection

☑ This appliance does not contain gasses which could damage the ozone layer, in either its refrigerant circuit or insulation materials. The appliance shall not be discarded together with the urban refuse and rubbish. The insulation foam contains flammable gases: the appliance shall be disposed according to the appliance regulations to obtain from your local authorities. Avoid damaging the cooling unit, especially the heat exchanger. The materials used on this appliance marked by the symbol ♻ are recyclable.

♻ This symbol on the product or on its packaging indicates that this product may not be treated as household waste. Instead it should be taken to the appropriate collection point for the recycling of electrical and electronic equipment. By ensuring this product is disposed of correctly, you will help prevent potential negative consequences for the environment and human health, which could otherwise be caused by inappropriate waste handling of this product. For more detailed information about recycling of this product, please contact your local council, your household waste disposal service or the shop where you purchased the product.

## Packaging materials

The materials with the symbol are recyclable. Dispose the packaging in a suitable collection container to recycle it.

## Disposal of the appliance

1. Disconnect the mains plug from the mains socket.
2. Cut off the mains cable and discard it.



⚠ WARNING! During use, service and disposal of the appliance, please pay attention to the symbol shown on the left, which is located on the rear of the appliance (rear panel or compressor) and in a yellow or orange color. It indicates risk of fire. There are flammable materials in the refrigerant pipes and compressor. Please keep away from source of fire during use, service and disposal.

# Overview

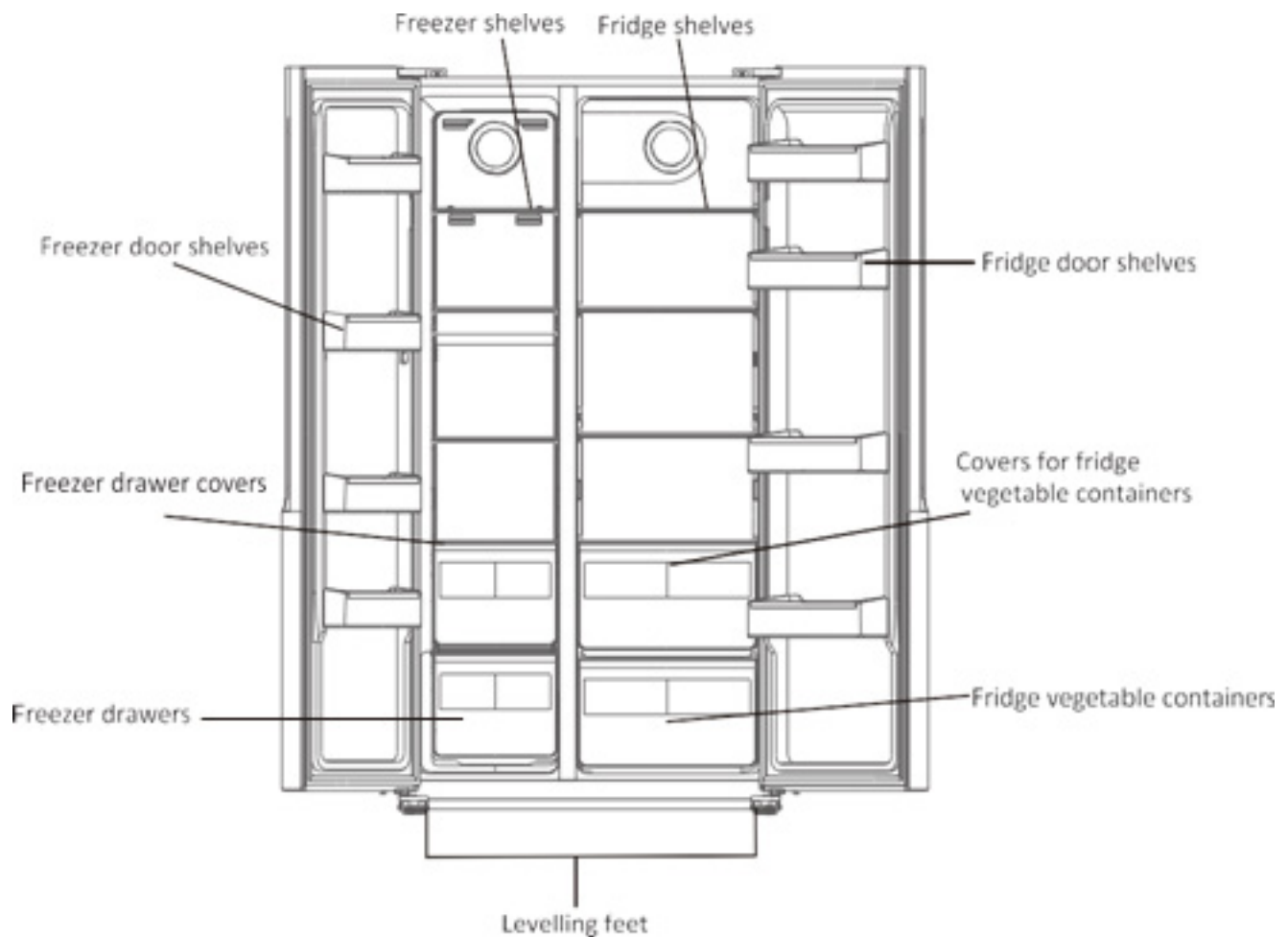

Note: Above picture is for reference only. Real appliance may be different.

## Installation

### Remove the doors

Tools required: Philips screwdriver. Flat bladed screwdriver.

- Ensure the unit is unplugged and empty.
- To take the door off it is necessary to tilt the unit backwards. Rest the unit on something solid so that it will not slip during the door removing process.
- All parts removed must be saved for reinstallation of the door.
- Do not lie the unit flat, as this may damage the coolant system.
- 2 people are recommended to handle the unit during assembly.



1. Unscrew hinge cover using a Philips screwdriver.

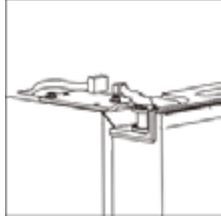

2. Disconnect the harness.

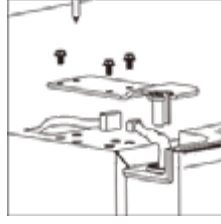

3. Unscrew top hinge.



4. Lift the door and place it on a soft pad. Remove the other door using the same process.

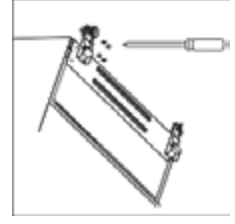

5. Unscrew bottom hinges.

After the appliance is positioned, install the doors using the reverse process.

## Space Requirement

- Select a location without direct exposure to sunlight.
- Select a location with enough space for the refrigerator doors to open easily
- Select a location with level (or nearly level) flooring.
- Allow sufficient space to install the refrigerator on a flat surface.
- Allow clearance to the right, left, back and top when installing. This will help reduce power consumption and keep your energy bills lower.

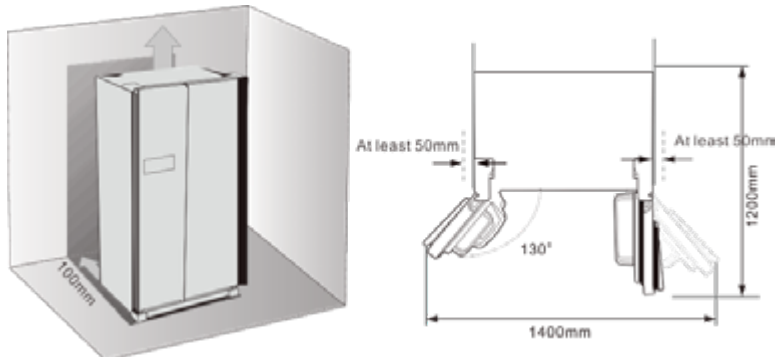

## Levelling the refrigerator

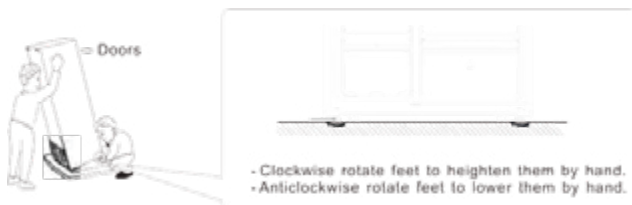



## Positioning

Install this appliance at a location where the ambient temperature corresponds to the climate class indicated on the rating plate of the appliance:

Climate class	Ambient temperature
SN	+10° C to +32° C
N	+16° C to +32° C
ST	+16° C to +38° C
T	+16° C to +43° C

## Location

The appliance should be installed well away from sources of heat such as radiators, boilers, direct sunlight etc. Ensure that air can circulate freely around the back of the cabinet. To ensure best performance, if the appliance is positioned below an overhanging wall unit, the minimum distance between the top of the cabinet and the wall unit must be at least 100mm. Ideally, however, the appliance should not be positioned below overhanging wall units. Accurate levelling is ensured by one or more adjustable feet at the base of the cabinet.

**⚠ WARNING!** It must be possible to disconnect the appliance from the mains power supply; the plug must therefore be easily accessible after installation.

## Electrical connection

Before plugging in, ensure that the voltage and frequency shown on the rating plate correspond to your domestic power supply. The appliance must be earthed. The power supply cable plug is provided with a contact for this purpose.

# Daily Use

## Using the Control Panel

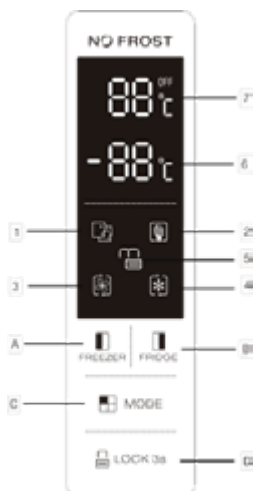





### Buttons

- A. Press to adjust temperature of freezer compartment (left side) from -14°C to -22°C.
- B. Press to adjust temperature of fridge compartment (right side) from 2°C to 8°C and off cooling.
- C. Press to select running mode from SMART, ECO, SUPER COOLING, SUPER FREEZING and USER'S SETTING (no symbol in display).
- D. Press LOCK 3 S button and hold for 3 seconds to lock the other three buttons. Press it and hold for 1 second to unlock the other three buttons.

## Display

1. SMART mode, the refrigerator sets the temperature of two compartments automatically according to internal temperature and ambient temperature.
2. ECO mode, the refrigerator runs in lowest energy consumption setting.
3. SUPER COOLING cools the fridge compartment to the lowest temperature as designed. After approx. 2.5 hours, the temperature setting will be restored to the previous user setting mode.
4. SUPER FREEZING cools the freezer compartment to the lowest temperature as designed. After approx. 50 hours, the temperature setting will be restored to the previous user setting mode.  
 Tips: it's better to switch on SUPER FREEZING mode 24 hours ahead before large amount of food is placed in the freezer compartment.
5. LOCK, the symbol will light on if buttons are locked.
6. Displays the setting temperature of freezer compartment.
7. Displays the setting temperature of fridge compartment.

In the event of a power failure, locked buttons will become unlocked.  
 Lock mode will turn on automatically 25 seconds after last operation.  
 Some features may not be applicable with this model.

Mode	Indicator light	Freezer temperature display	Fridge temperature display
Smart		The temperature display for freezer and fridge will change based on ambient temperature (see the table below)	
Eco		-15°C	+8°C
Super cooling		No change	+2°C
Super freezing		-25°C	No change

### Notes:

ECO mode: Select this mode when you want to save power.

Super cooling mode: This mode allows you to cool food quickly and will be automatically deactivated after 2.5 hours of operation.

Super freezing mode: This mode allows you to freeze food quickly and will be automatically deactivated after 50 hours of operation.

## Door open alarm

When any door is left open or not closed completely for about 90 seconds, the appliance will sound an alarm. Close the fridge door to stop the alarm. If the door is not completely closed, the alarm will sound every 35 seconds until the doors are closed. If doors are open for 10 continuous minutes, the internal LED light will be turned off automatically.

## Child safety lock (LOCK MODE)

This function is designed to prevent children from operating the appliance. See description of operation above. The lock indicator light will display whether the buttons are locked or unlocked.



## First use

### Cleaning the interior

Before using the appliance for the first time, wash the interior and all internal accessories with lukewarm water and some neutral soap so as to remove the typical smell of a brand new product, then dry thoroughly.

Important! Do not use detergents or abrasive powders, as these will damage the finish.

Position different food in different compartments according to the table below

Refrigerator compartments	Type of food
Door or balconies in fridge compartment	<ul style="list-style-type: none"> <li>• Foods with natural preservatives, such as jams, juices, drinks, condiments.</li> <li>• Do not store perishable foods.</li> </ul>
Crisper drawer (salad drawer)	<ul style="list-style-type: none"> <li>• Fruits, herbs and vegetables should be placed separately in the crisper bin.</li> <li>• Do not store bananas, onions, potatoes or garlic in the refrigerator.</li> </ul>
Fridge shelf – bottom Chiller (box/drawer)	Raw meat, poultry, fish (for short-term storage)
Fridge shelf – middle	Dairy products, eggs
Fridge shelf – top	Foods that do not need cooking, such as ready-to-eat foods, deli meats, leftovers.
Freezer drawer(s)/shelf	<ul style="list-style-type: none"> <li>• Foods for long-term storage.</li> <li>• Bottom drawer/shelf for raw meat, poultry, fish.</li> <li>• Middle drawer/shelf for frozen vegetables, chips.</li> <li>• Top drawer/shelf for ice cream, frozen fruit, frozen baked goods.</li> </ul>

## Freezing fresh food

- The freezer compartment is suitable for freezing fresh food and storing frozen and deep-frozen food for a long time.
- Place the fresh food to be frozen in the bottom compartment
- The maximum amount of food that can be frozen in 24 hours is specified on the rating plate.
- The freezing process lasts 24 hours: during this period do not add other food to be frozen

## Thawing

Deep-frozen or frozen food, prior to be used, can be thawed in the freezer compartment or at room temperature, depending on the time available for this operation. Small pieces may even be cooked still frozen, directly from the freezer. In this case, cooking will take longer.

## Ice cube maker

This appliance may be equipped with one or more ice cube makers.

## Movable shelves

The walls of the refrigerator are equipped with a series of runners so that the shelves can be positioned as desired.

## Positioning the door balconies

To permit storage of food packages of various sizes, the door balconies can be placed at different heights. To make these adjustments proceed as follows: gradually pull the balcony in the direction of the arrows until it comes free, then reposition as required.



# Helpful tips

## Tips for freezing

To help you make the most of the freezing process, here are some important tips:

- The maximum quantity of food which can be frozen in 24 hours is shown on the rating plate.
- The freezing process takes 24 hours. No further food to be frozen should be added during this period.
- Only freeze top quality, fresh and thoroughly cleaned, foodstuffs.
- Prepare food in small portions to enable it to be rapidly and completely frozen and to make it possible subsequently to thaw only the quantity required.
- Wrap up the food in aluminium foil or polythene and make sure that the packages are airtight.
- Do not allow fresh, unfrozen food to touch food which is already frozen, thus avoiding a rise in temperature of the latter.
- Lean foods store better and longer than fatty ones. Salt reduces the storage life of food.
- It is advisable to show the freezing in date on each individual pack to enable you to keep tab of the storage time.

## Tips for storage of frozen food

To obtain the best performance from this appliance, you should:

- Make sure that the commercially frozen foodstuffs were adequately stored by the retailer.
- Be sure that the frozen foodstuffs are transferred from the food store to the freezer in the shortest possible time.
- Do not open the door frequently or leave it open longer than absolutely necessary.
- Once defrosted, food deteriorates rapidly and cannot be refrozen
- Do not exceed the storage period indicated by the food manufacturer.

## Tips for fresh food refrigeration

To obtain the best performance:

- Do not store warm food or evaporating liquids in the refrigerator
- Cover or wrap the food, particularly if it has a strong flavour.

## Tips for refrigeration

- Make (all types): wrap in polythene bags and place on the glass shelves above the vegetable drawer.
- For safety, store in this way only one or two days at the most.

- Cooked foods, cold dishes, etc...: these should be covered and may be placed on any shelf.
- Fruit and vegetables: these should be thoroughly cleaned and placed in the special drawer(s) provided.
- Butter and cheese: these should be placed in special airtight containers or wrapped in aluminium foil or polythene bags to exclude as much air as possible.
- Milk containers: these should be closed and should be stored in the balconies on the door.
- Bananas, potatoes, onions and garlic, if not packed, must not be kept in the fridge.

# Cleaning

For hygienic reasons the appliance interior, including interior accessories, should be cleaned regularly.

⚠ Caution! The appliance may not be connected to the mains during cleaning. Danger of electrical shock! Before cleaning switch the appliance off and remove the plug from the mains, or switch off or turn out the circuit breaker or fuse. Never clean the appliance with a steam cleaner. Moisture could accumulate in electrical components, danger of electrical shock! Hot vapors can lead to the damage of plastic parts. The appliance must be dry before it is placed back into service.

Important! Ethereal oils and organic solvents can attack plastic parts, e.g. lemon juice or the juice from orange peel, butyric acid, cleanser that contain acetic acid.

- Do not allow such substances to come into contact the appliance parts.
- Do not use any abrasive cleaners
- Remove the food from the freezer. Store them in a cool place, well covered.
- Switch the appliance off and remove the plug from the mains, or switch off or turn out the circuit breaker or fuse.
- Clean the appliance and the interior accessories with a cloth and lukewarm water. After cleaning wipe with fresh water and rub dry.
- After everything is dry place appliance back into service.

# Troubleshooting

⚠ Caution! Before troubleshooting, disconnect the power supply. Only a qualified electrician of competent person must do the troubleshooting that is not in this manual.

Important! There are some sounds during normal use (compressor, refrigerant circulation).

Problem	Possible cause	Solution
Appliance does not work	Mains plug is not plugged in or is loose	Insert mains plug.
	Fuse has blown or is defective	Check fuse, replace if necessary.
	Socket is defective	Mains malfunctions are to be corrected by an electrician.
Appliance freezes or cools too much	Temperature is set too cold or the appliance runs at SUPER modes.	Turn the temperature regulator to a warmer setting temporarily.
The food is not frozen enough.	Temperature is not properly adjusted.	Please look in the initial Temperature Setting section.
	Door was open for an extended period.	Open the door only as long as necessary.
	A large quantity of warm food was placed in the appliance within the last 24 hours.	Turn the temperature regulation to a colder setting temporarily.
	The appliance is near a heat source.	Please look in the installation location section.
Heavy build up of frost on the door seal.	Door seal is not air tight.	Carefully warm the leaking sections of the door seal with a hair dryer (on a cool setting). At the same time shape the warmed door seal by hand such that it sits correctly.
Unusual noises	Appliance is not level.	Re-adjust the feet.
	The appliance is touching the wall or other objects.	Move the appliance slightly.
	A component, e.g. a pipe, on the rear of the appliance is touching another part of the appliance or the wall.	If necessary, carefully bend the component out of the way.
Side panels are hot	This is normal. Heat exchanger is in the side panels.	

If the malfunction shows again, contact your point of purchase.